



# extreme

## ENGINEERING

ENGINEERING DESIGN / FAMILY COASTERS / ADVENTURE RIDES

---

SINCE 1995

# WE SHARE YOUR PASSION...

## OUR CULTURE IS OUR CUSTOMERS

 Extreme Engineering is a manufacturing and engineering firm of award winning amusement rides based outside of Dallas, Texas. Since 1995, Extreme Engineering has been recognized as the industry leader in family-friendly attractions to world-class destinations and amusement parks. With over 1,000 customers worldwide, chances are you have experienced our rides firsthand. Extreme Engineering has provided innovative solutions to both Fortune 100 and 1000 companies, such as Six Flags, Disney, Universal, Bluegreen Resorts, Holiday Inn and others. For over 25 years when it comes to safe, new and exciting attractions Extreme Engineering has been the answer.

Today Extreme Engineering is the industry's leading choice for engineering design, family coasters and adventure rides. We make endless design opportunities possible through our talented team of design engineers and experienced sales experts. From award winning attractions to engineering design, let's just say we have your creative mind's back! We are passionate, active industry members. Our team volunteers on safety committees, helps with creating industry standards to even serving on the IAAPA Board of Directors. We do this because we believe in this industry, we believe in safety and truly understand the importance of creating positive experiences for families to enjoy.

Our staff wakes up every day ready to ride the next new rollercoaster and visit world-class theme parks. We are always prepared to design the future in entertainment but we don't just stop here. Innovation, industry standards, experience and breakthrough designs come standard in all of our attractions. In order to preserve our industry's future, Extreme Engineering understands the importance of integrity, honesty, creativity and the protection of ideas. While others might try to attempt what we do, our company will most certainly have already moved on. We are dynamic in what we do, we believe in inventing forward. Our staff constantly looks ahead and strives on giving customers the real cutting-edge they deserve. Our company motto, "fun is our business," is what we believe in. This belief allows us to transform creative ideas into reality.

Pictured: Jeff Wilson, CEO of Extreme Engineering.

# NONSTOP SERVICE TO THE SKY



**EXTREME  
AIR**

Welcome aboard the Extreme Air™, with nonstop service up to 25 feet in the sky. Stretch out your arms and legs, smell the air, touch the sky and see for yourself why the amazing honor of "Best New Product" two years running was bestowed upon this powerhouse in the jumping industry. Every patented jumper system comes with the best features on the market and exceeds ASTM, CE and other industry standards.

Extreme Engineering only uses the best materials available in the production process of every Extreme Air™ jumper. The extruded fiber-woven poles, "Flex Pole Technology™," supports a wide range of weights. With faster cycle times, wireless remote technology, less staff and less maintenance costs, you will be jumping for joy with the Extreme Air™.

**SOAR ABOVE OTHERS**



## ADVENTURE CAN BE YOURS

Awarded best new product, two years in a row, by IAAPA. This is the best jumper on the market.



## WANT TO KNOW WHAT IT FEELS LIKE TO FLY?

Take flight on the best air jumper on the market.



**W**e provide the engineering geek, marketing sleek and business sales success all in one! Our products are designed by a team of the most talented aeronautical and mechanical engineers, business professionals, and marketing gurus in the world. Extreme Engineering only uses the best materials available in the production process of every Extreme Air.

**WE ARE  
YOUR ADVENTURE  
ENTHUSIASTS**



As Shown: Mobile Extreme Air™ In Line Jumper

# EXTREME AIR JUMPER

U.S. patent number: 7,182,695.

There are jumpers and then there are Extreme Engineering jumpers. The Extreme Air™ jumper systems use patented fiberglass pole technology, allowing participants to soar up to 25 feet in the air! With set-up times of just 20 minutes you will be spending more time making money and less time battling set-up. The Extreme Air™ jumper systems are the only kind on the market to use wireless remote technology, removing the amount of staff needed. With innovative technology, design and other state-of-the-art components, the cost of ownership is just a fraction of all other air jumper systems on the market. The dynamic fiberglass poles, "Flex Pole Technology™," supports a wide range of weights, eliminating the mounds of harness sizes needed. With faster cycle times, less staff and less maintenance costs, why would you jump anywhere else? Give yourself a product you are proud to present.

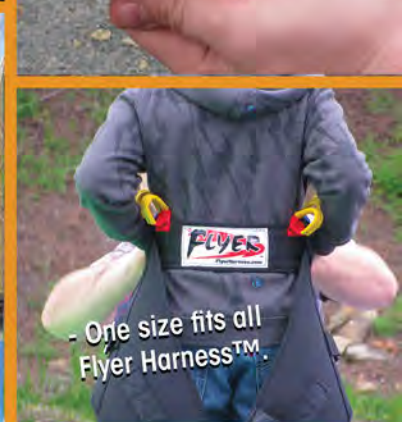
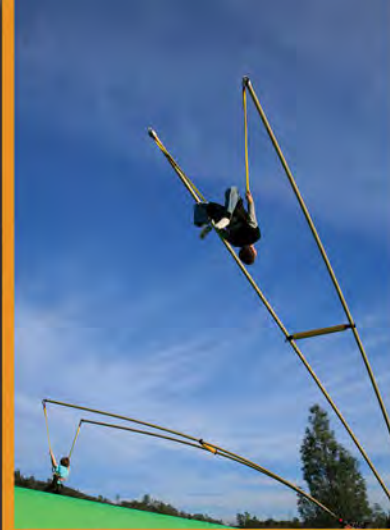

# FLYER HARNESS

Faster, Safer, Better.



The breakthrough features on the new Flyer Harness™ makes it the most comfortable and universal harness on the market! With wide and padded leg straps, a fully adjustable waist belt and industry standard buckles, this is the jumper harness of choice! Junior sizes are also available for small children. Harnesses are compatible with any jumper system!



# OUR FEATURES ARE FOCUSED ON YOU

We work closely with leaders in our industry to provide solutions that really work. This is why the Extreme Air™ is the only two-time jumper winner at IAAPA.

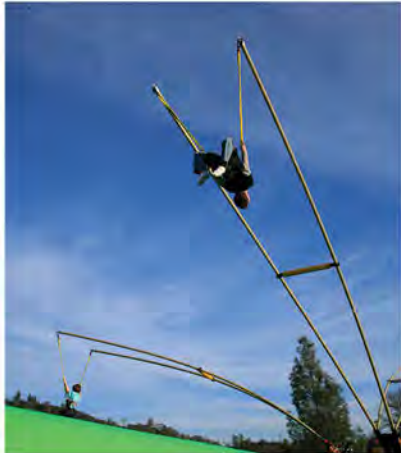

## FLEX POLE TECHNOLOGY™

The patented "Flex Pole Technology,™" allows operation of the equipment without cumbersome turn buckles and bungee cords. This exclusive pole technology, with an inflatable pad, allows participants to spring up to 25 feet in the air with ease. The poles store crazy amounts of energy and are incredibly strong (can hold over 5,000lbs).



## UP TO 4 RIDERS AT A TIME

The Extreme Air™ will take you leaps and bounds above the competition! Allow up to 4 riders at a time. You'll be able to move participants quickly on and off the product, enhancing profitability. The operator has complete custom remote con-

## MOBILE VERSION AVAILABLE

Industry's most popular mobile jumper on the market. Set up in just 20 minutes and allow up to 4 riders at a time!



The Extreme Air™ jumper exceeds ASTM, CE and other industry standards.



# MOBILE EXTREME AIR

U.S. patent number: 7,182,695.

## Mobile Extreme Air (4 Person Jumper)

SOAR TO GREAT HEIGHTS.

**Weight Limit:** 45-250 lbs (20-114 KG)  
**Jumpers:** 4 Jumpers  
**Height:** Up to 25' (7.6 Meters)  
**Surface Area:** 1350 SF (441.60 Meters)  
**Travel Height:** 4'0" (1.2 Meters)  
**Travel Width:** 90" (2.3 Meters)  
**Dry Weight:** 3,500 lbs (1,588 KG)  
**Power:** 110V AC 60HZ (15 AMPS)  
**Poles:** Flex Pole Technology

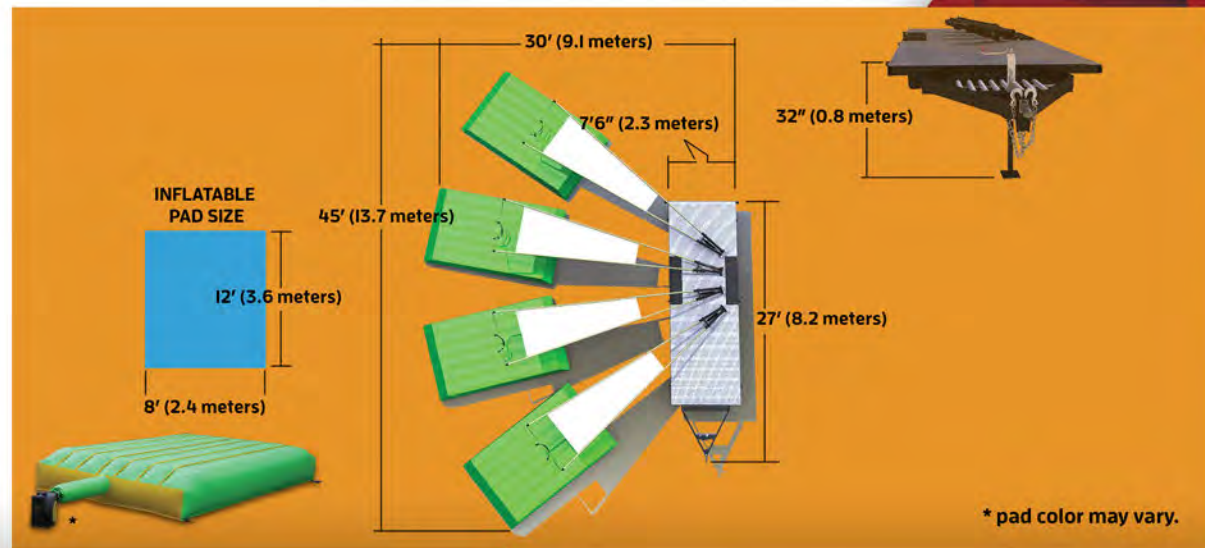





# STATIONARY EXTREME AIR

U.S. patent number: 7,182,695.



TANDEM JUMPER CONFIGURATION

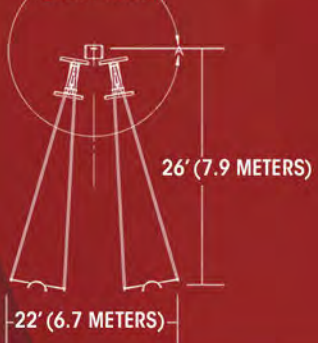

QUAD JUMPER CONFIGURATION

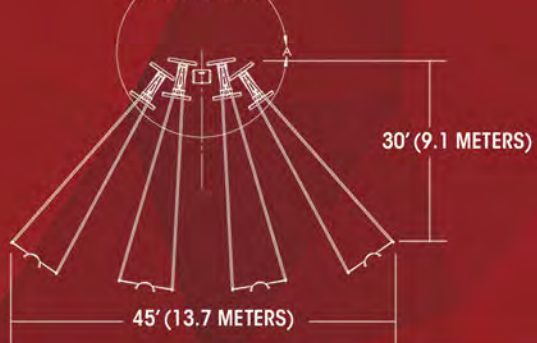

INFLATABLE PAD SIZE

12' (3.6 METERS)

8' (2.4 METERS)

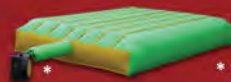

\* pad color may vary.



Single Extreme Air™ units also available.

# PERFECT FOR MANY MARKETS

We make adventure versatile.

This attraction is perfect for the following markets:



AMUSEMENT PARK



RESORT



SPORTING ARENA



WATER PARK

## ASK ABOUT OUR OTHER AWARD WINNING ATTRACTIONS



SUSPENDED ROLLER COASTERS



MOBILE CLIMBING WALLS



CLIMBING ATTRACTIONS



ZIPLINES

**Extreme Engineering**  
1391 Flat Creek Road  
Athens, TX 75751  
916.663.1560  
[www.extremeengineering.com](http://www.extremeengineering.com)



**FUN IS OUR BUSINESS™**

U.S. Patents 6,653,142, 6,390,952, 6,659,496, 7,182,695 and International Patents Pending. Extreme Engineering, Extreme Engineering's Logo, Speed Harness Fun is our Business, Fly Wire Zipline, High-Action Adventure, Adventure Products, Extreme Air, Rapid Gravity Ride, Cloud Coaster, Flex Pole Technology, Auto-Zip, and Decelerator are U.S. registered trademarks of Extreme Engineering. We take our intellectual property seriously and protect all of our patents, trademarks and copyrights. Our company believes in the protection of ideas so that creative minds can always invent. Help us by honoring originality in this industry. Always buy from the source so that patents can be treated with respect. This material is copyrighted and may not be duplicated without written permission from Extreme Engineering.

Catalog design by: Phil Wilson