



HIGH-ACTION ADVENTURES

Where Resorts and Parks go from ordinary to EXTREME.



ABOUT US

Founded in 1995 by Jeff Wilson, Extreme Engineering is the largest supplier in adventure equipment to the resort and entertainment industries, and is the leader in extreme, interactive fun. With over 5,000 customers worldwide including Disney, NASA, Marriott, Holiday Inn Vacation Club, Vail, Cirque du Soleil, Six Flags, Westgate, One & Only Resorts and Atlantis, Extreme Engineering advocates industry growth and development through adventure. Extreme Engineering is highly recognized by industry leaders, holding eight awards in technology and Best New Product categories for the entertainment market. Extreme Engineering's goal is to provide "stay-to-play" solutions to keep guests engaged and entertained through safe thrills and memories that last a lifetime.

Our "fun-amenities" enhance theme parks and resorts, resonating with pure-play excitement! We stay true to our motto, "We create memories through excitement."

High Action Adventure™

Our exclusive adventure solution, High-Action Adventure™, incorporates all of Extreme Engineering's award winning attractions into one place. Guests are transformed into thrill-seekers through zip lining, air jumping, conquering challenge courses, rock climbing and more. The High-Action Adventure™ can be scaled, portable or stationary and custom themed to fit into any environment. These amenities are engineered to exceed industry standards, provide safety with no risk, require minimal staffing and are fun for all ages. We make "fun your business" and ensure that your guests experience, live and breathe adventure.

— WE ARE —
**YOUR ADVENTURE
ENTHUSIASTS**

OUR CLIENTS

We provide the best to the best in the world! Extreme Engineering works globally with over 5,000 clients.

Here are just some of our clients:



8-Time Award Winner At IAAPA

EXPLORE SOME EXTREME ENGINEERING



| | |
|-------------------------|---------|
| OUR CLIENTS | //82 |
| HIGH-ACTION ADVENTURES™ | //84-87 |
| THEMING AND DESIGN | //88 |
| POTENTIAL PROFIT | //89 |
| MOBILE SOLUTIONS | //18-17 |

SAFE FUN

Engineering geeks. Marketing sleek.
Business brilliance. All in one
savvy company.

CLIMBING WALL

Are you ready to rock?

Get ready to turn the volume up to eleven with Extreme Engineering's large assortment of rock climbing walls. Our company was built on a foundation of rock solid climbing walls specifically designed to provide our consumers with a profitable, safe and thrilling experience. We offer three different types of installations to rock your world, if you can handle it.

EXTREME AIR™

Soar above others.

Want to know what it feels like to fly? Welcome aboard the Extreme Air™ with nonstop service up to 25 feet in the sky. Stretch out your arms and legs, smell the air, touch the sky and see for yourself why the amazing honor of "Best New Product" two years running was bestowed upon this powerhouse in the jumping industry. Our patented fiberglass pole technology and wireless control make this product easy to operate.

ROPE QUEST™

The ultimate journey.

Take on the ultimate challenge of the Rope Quest™, an interactive rope-course structure that allows children and heroes to explore, crawl, climb and slide in absolute safety. Overcome six levels in the twisted net system, compete with your friends, conquer challenges and for your grand finale, launch down a 30 foot inflatable slide!

FLY WIRE™ ZIPLINE

Winner of Best Major Theme Park Ride.

Feel the rush of freedom while you soar to new heights! Thrill-seekers of all ages will be lining up to experience an up to 21MPH rush on the industry's safest zip line available. The Fly Wire™ is an infinitely adjustable system and uses the safest stopping device on the market, the Decelerator™, which keeps riders safely off the ground at all times.



HIGH-ACTION ADVENTURES™



THE ANATOMY OF ADRENALINE

Leave the 9-5 behind...you're on an adventure.

The High-Action Adventure™ can generate serious revenue as an additional attraction or added value piece.

The High-Action Adventure™ empowers your team to offer more on-site activities to your guests. This is a perfect sales solution to enhance the stay-to-play experience.

Guests do not have to leave your property for excitement and entertainment!

This solution is designed to attract new, youthful attendees.

The High-Action Adventure™ incorporates popular attractions all in one place.

All of our award winning products are engineered to offer the very best in quality and safety. Every product we manufacture meets and/or exceeds industry standards. If you want innovation at its best, then look no further.

IT'S FUN FOR ALL AGES!

WHERE WILL YOUR ADVENTURE TAKE YOU?



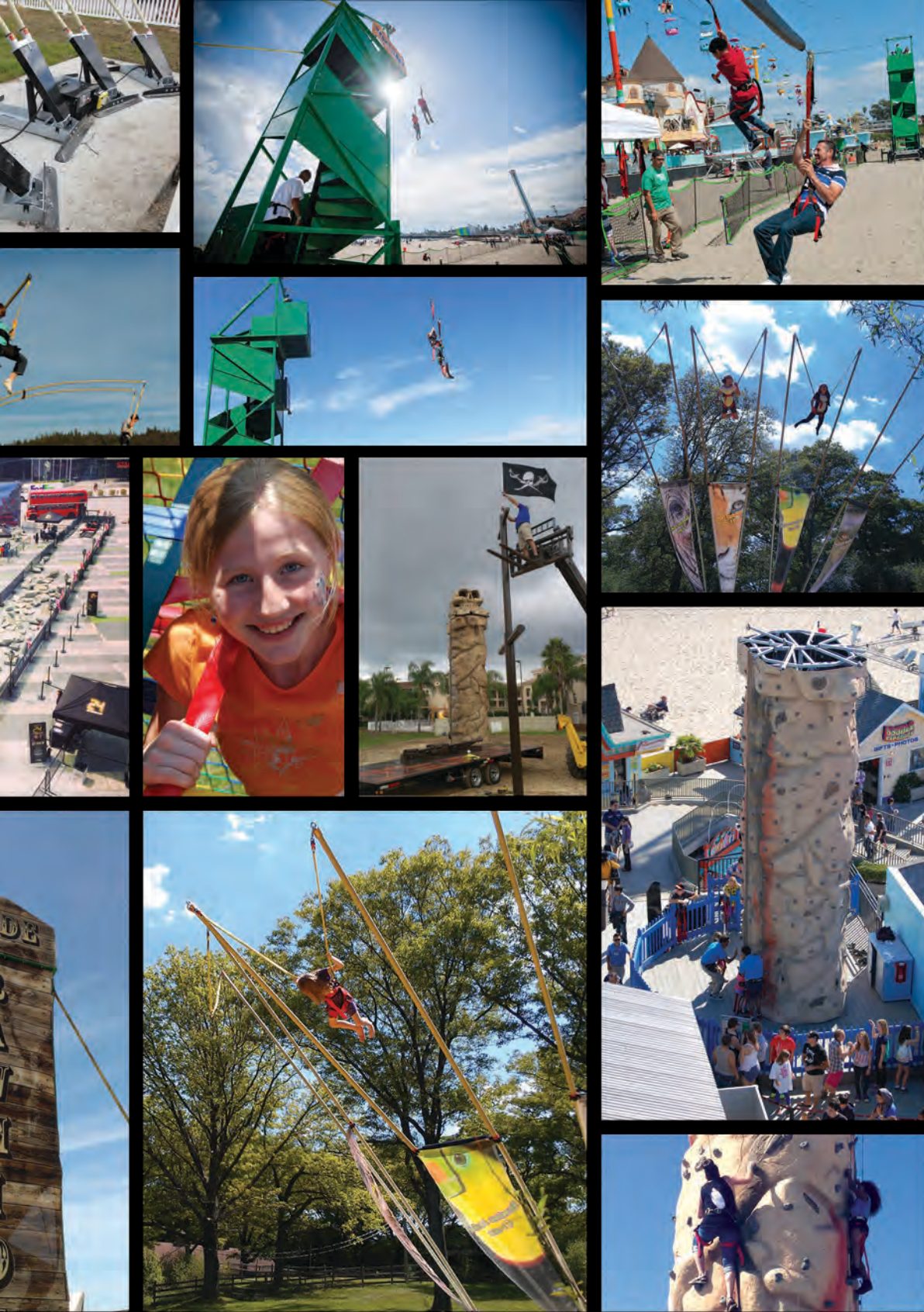

**You get them to check-in,
we get them to check you out...**



Designed to attract new, youthful, millennial attendees, the High-Action Adventure™ can generate serious revenue as an additional attraction or added value piece to your already stellar amenities.

From start to finish, we help you design a unique, fun experience to provide your guests. Our stay-to-play concepts allow your creativity to shine.

Our award winning design team carefully focuses on interactive attractions that are popular in today's market. We ensure that all of our adventure products are created for the next generation of thrill-seekers.

The High-Action Adventure™ is scalable, can be themed and is designed to attract new, youthful buyers.

Our process is simple. Here is how it works:

1. You provide us with your available space.
2. We present you with layouts, options and illustrations.
3. We assist you in the correct product mix.
4. You give us your theming desires, we create the reality.
5. We install your equipment, train your staff, and help with any promotions necessary.
6. Your guests start having fun, you start making money.

THEMING AND DESIGN



Fly like Tarzan, be a swashbuckling pirate or go on a safari adventure...

Let's Co-Create! We provide the vision, you provide the experience. Our in-house theming experts provide world-class solutions to fit into any environment. From rendering to reality, allow your creativity to shine while creating the adventure of your dreams. From start to finish, we help you design a unique, fun experience to provide your guests a vacation to remember.



POTENTIAL PROFIT

Let's generate some serious cash flow.



| Product | Capacity Per Hour | Price Per Attraction |
|---------------------------|-------------------|----------------------|
| High-Action Adventure™ | Up to 300 riders | \$20 - \$30 |
| Fly Wire™ Zipline | Up to 90 riders | \$10 - \$15 |
| Extreme Air™ | Up to 90 riders | \$6 - \$8 |
| Rope Quest™ | Up to 120 riders | \$4 - \$6 |
| Mobile Climbing Walls | Up to 100 riders | \$5 - \$7 |
| Stationary Climbing Walls | Up to 150 riders | \$5 - \$7 |

*Potential profit can vary depending on product mix or size of High-Action Adventure™. This spreadsheet demonstrates what our products have earned with current clients throughout the U.S. Please only use these numbers, as a reference, on what your earning potentials can achieve.



AWARD WINNING SOLUTIONS

Fun is our business!™

Since the invention of the first, patented mobile climbing wall in 1995, Extreme Engineering has the most experience in engineering and design of adventure products™ in the world. All of Extreme Engineering's major attractions have won Best New Product awards and are built from the best quality materials available. Every product we design exceeds ASTM, CE and other industry standards. We only provide the best, engineered adventure products™ available!

Our solutions have many advantages and can benefit your business and promotional needs. All of Extreme Engineering's attractions set up quickly and can be easily installed in almost any environment. The flexibility of our adventure products allows you to customize your adventure experience at any time.





**ADVENTURE
CAN BE YOURS**

1, 2, 3, 4, 5, 6, 7 and yes 8
industry awards...

Get Ready To Take Flight

FLY WIRE ZIPLINE™

AWARDED BEST MAJOR THEME PARK RIDE AT IAAPA

Fly Wire Zipline™

FEEL THE RUSH OF FREEDOM WHILE YOU SOAR TO NEW HEIGHTS.

| | |
|--------------------------|------------------------------------|
| Weight Limit: | 45-250 lbs (20-114 KG) |
| Operating Height: | 31' (9.53 Meters) |
| Operating Width: | 10' (3.05 Meters) |
| Operating Length: | *Up to 500' (152.45 Meters) |
| Decelerator: | Decelinator™ |

*Custom lengths and designs are available.

The Decelinator™, awarded on best technology applied, is a proprietary decelerator that uses compression spring technology to safely slow down zip liners. The Decelinator™ also keeps zip liners safely off the ground until the zipline stops. Zip liners are then safely hydraulically lowered to the ground. No other zipline on the market offers these safety features. Set up time is in just minutes, offering the fastest zipline cycle times in the industry. This is the amusement industry's zipline solution.



FLY WIRE
A ZIPLINE RIDE



Yes, you can zipline through waterparks, resorts, football fields and amusement parks with our Fly Wire Zipline™, the only awarded Best Major Theme Park Ride zipline on the market.

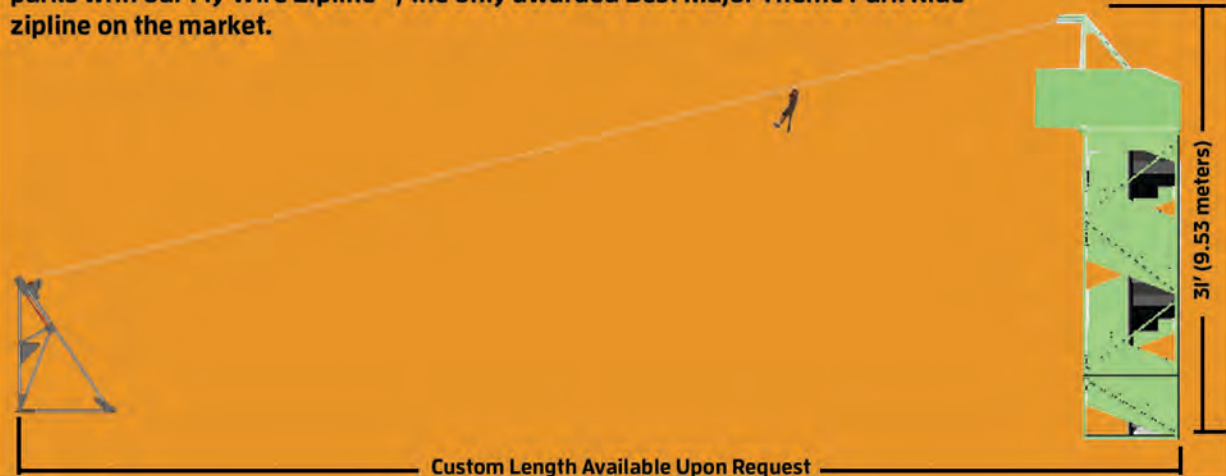

Custom Length Available Upon Request





MONDAYS SEPT FOX

A Ropescourse Ride

ROPE QUEST™

AWARDED HONORABLE MENTION AT IAAPA

Rope Quest™

WHERE WILL YOUR ADVENTURE TAKE YOU?

Weight Limit: 45-250 lbs (20-114 KG)
Operational Height: 20' (4.88 Meters)
Slide Specs*: 37'L x 20'H x 18'W (1 HP Blower)

* Slide color and configuration may vary.

Take on the ultimate challenge of the Rope Quest™, an interactive ropescourse attraction that allows children to explore, crawl, climb and slide in absolute safety. Overcome six levels in the twisted net system, compete with your friends, conquer challenges and for your grand finale, launch down a 30 foot inflatable slide.



* Custom theming is not included.

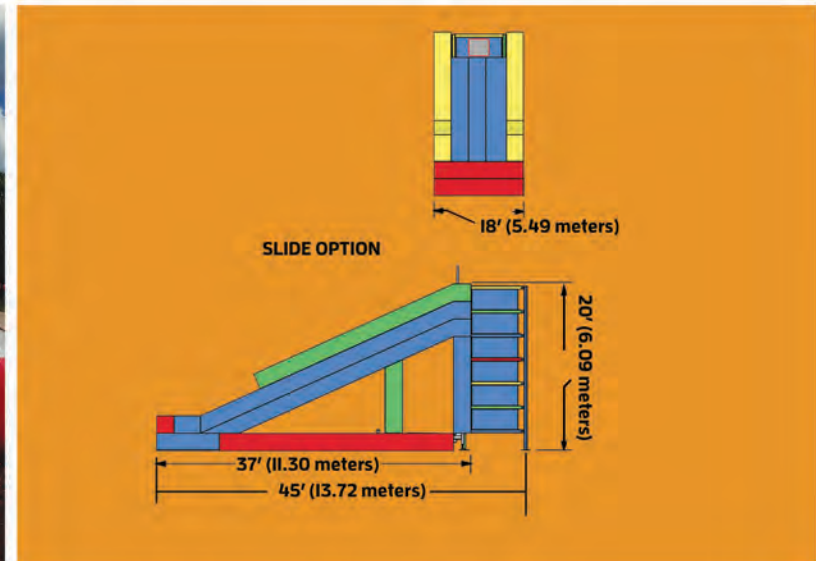

Soar Above Others

EXTREME AIR™

AWARDED BEST NEW PRODUCT 2 YEARS IN A ROW AT IAAPA

Extreme Air™ (In Line 4 Person Jumper)

WANT TO KNOW WHAT IT FEELS LIKE TO FLY?

- Weight Limit:** 45-250 lbs (20-114 KG)
- Height:** Up to 25' (7.6 Meters)
- Surface Area:** Up to 1,350 SF (441.60 Meters SQ)
- Power:** 110V AC 60HZ (15 AMPS)
- Poles:** Flex Pole Technology™



e HIGH-ACTION ADVENTURE™

Take flight on the best air jumper on the market. Welcome aboard the Extreme Air™, with nonstop service up to 25 feet in the sky. The dynamic fiberglass poles, "Flex Pole Technology™" supports a wide range of weights. With faster cycle times, wireless remote technology, less staff and less maintenance costs, you will be jumping for joy with the Extreme Air™.

TANDEM JUMPER CONFIGURATION

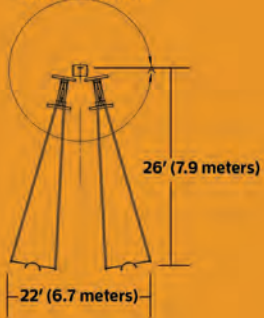

QUAD JUMPER CONFIGURATION

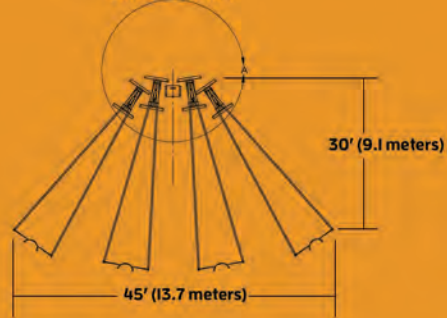

INFLATABLE PAD SIZE

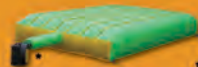

* pad color may vary.



A Prehistoric Adventure

ELEMENT CLIMBING WALL

ORIGINAL INVENTOR AND U.S. PATENT HOLDER

Element (Up to 8 Rock Climbers)
TAKE A PIECE OF EARTH WITH YOU.

Weight Limit: 45-250 lbs (20-114 KG)
Climbers: Up to 8 climbers
Height: Up To 26' (7.9 Meters)
Surface Area: Up To 780 SF (238 Meters)
Auto-belays™: Fully Redundant



Extreme Engineering is known as the pioneers in revolutionizing the climbing experience. Our patented Auto-belay™, is included on every Extreme Engineering climbing wall.

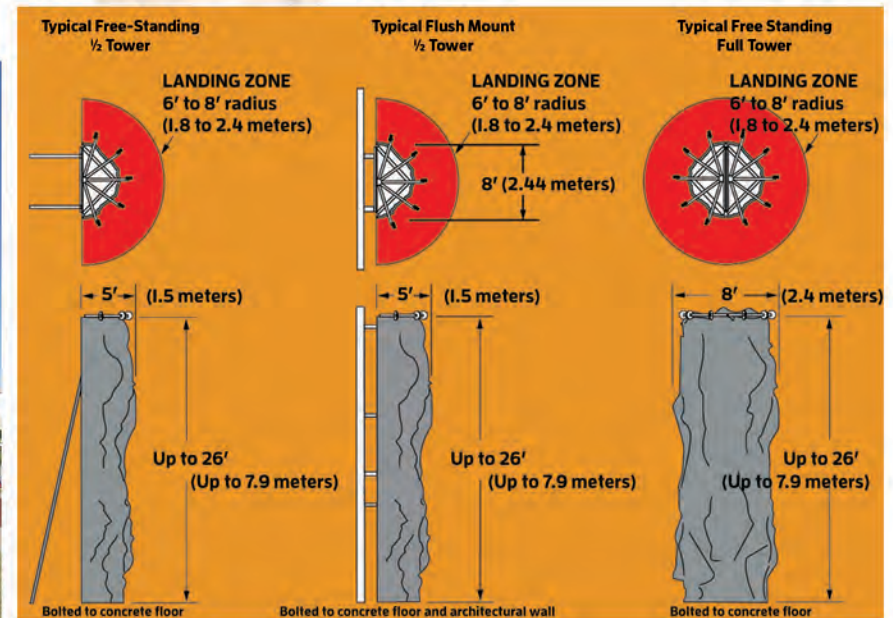

Move Aside Mt. Everest

MONOLITH CLIMBING WALL

ORIGINAL INVENTOR AND U.S. PATENT HOLDER

Monolith (Up to 10 Rock Climbers)
THE KING OF CLIMBING WALLS.

Weight Limit: 45-250 lbs (20-114 KG)
Climbers: Up to 10 climbers
Height: Up to 35' (10.67 Meters)
Surface Area: Up to 1200 SF (366 Meters)
Auto-belays™: Fully Redundant

The Monolith has up to 1200 square feet of climbing area, multiple overhangs, five distinct climbing routes and accomodates over 100 participants an hour.



e HIGH-ACTION ADVENTURE™

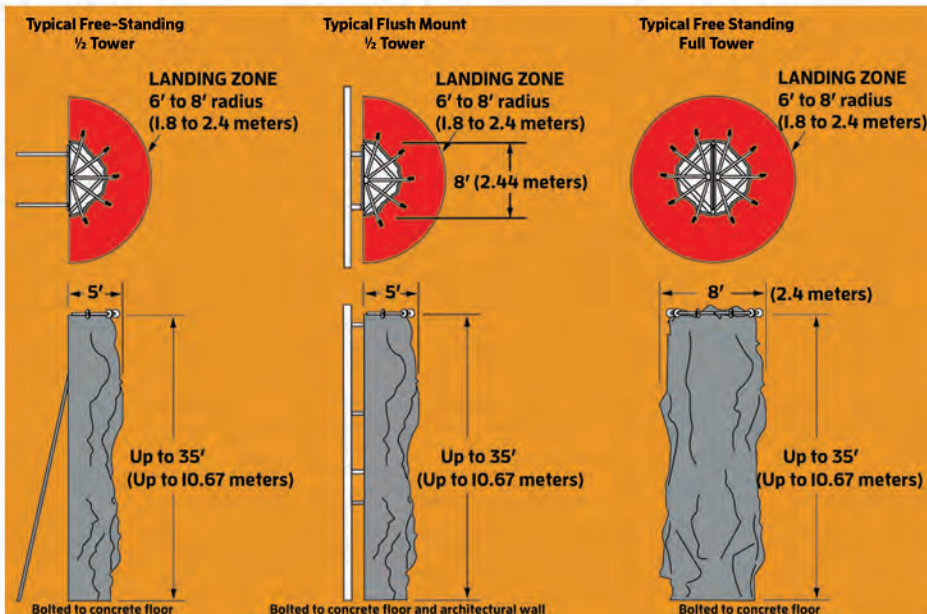

Modularity Is Great

SIERRA PANEL SYSTEM

ORIGINAL INVENTOR AND U.S. PATENT HOLDER

Sierra Panel System (4' x 4' panels) FULLY CUSTOMIZE YOUR CLIMBING EXPERIENCE!

Weight Limit: 45-250 lbs (20-114 KG)
Per Panel Height: 4' (1.2 Meters)
Per Panel Width: 4' (1.2 Meters)
Auto-belays™: Fully Redundant

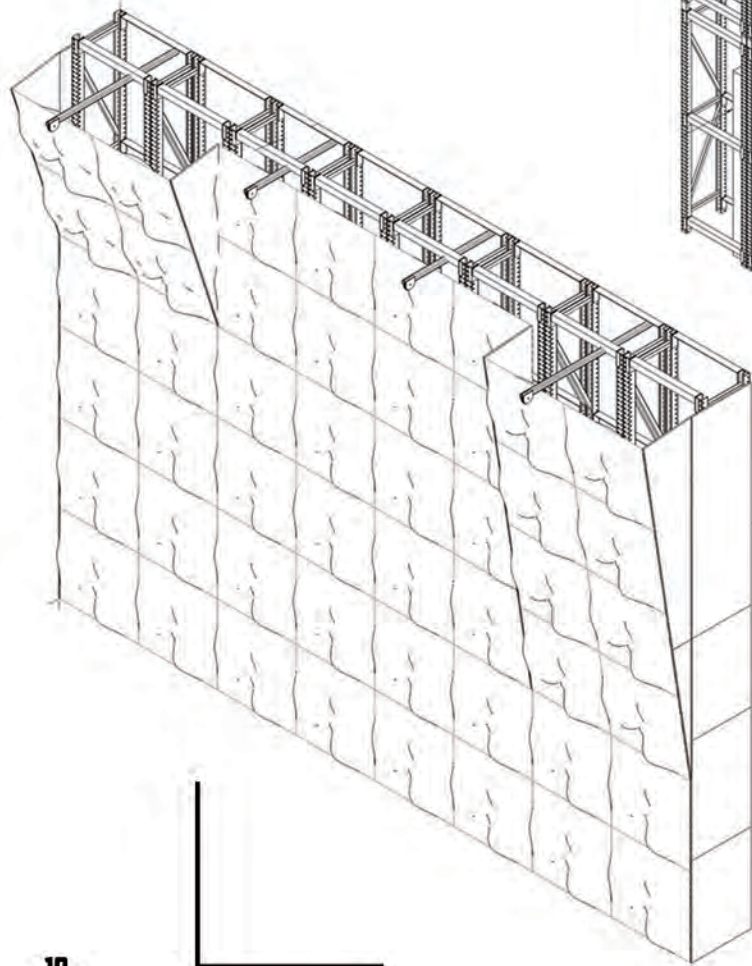
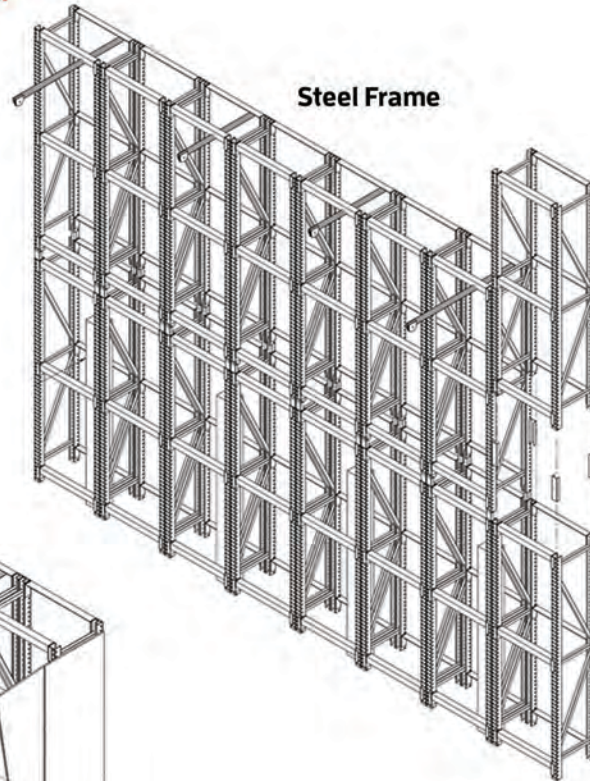

Let freedom ring with Extreme Engineering's Sierra Panel System, a modular climbing wall design. Designed to provide complete customization on your climbing wall project, the world is your oyster with this system designed for unique installation sites.



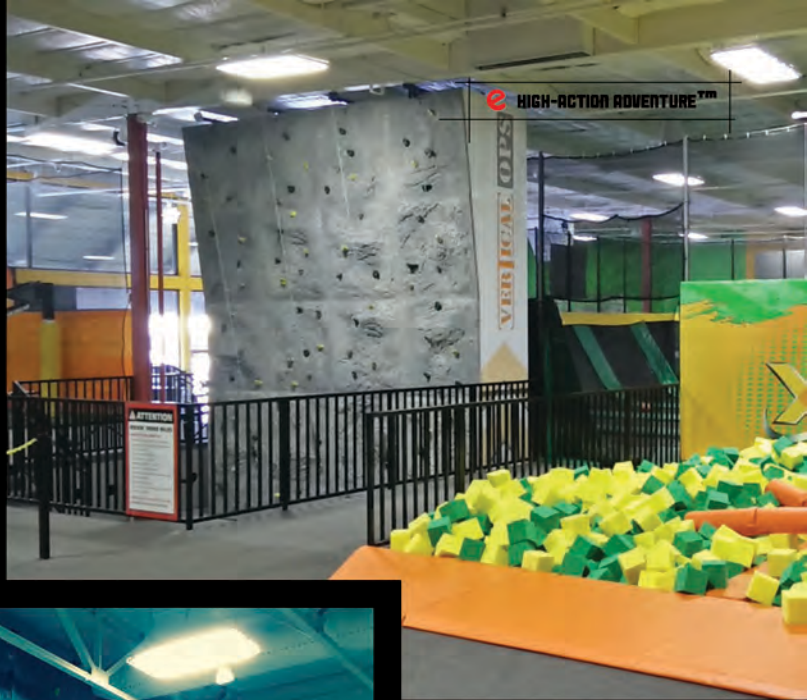

Extreme Engineering
1391 Flat Creek Road
Athens, TX 75751
916.663.1560
www.extremeengineering.com



FUN IS OUR BUSINESS™

U.S. Patents # 6,311,442, 6,390,952, 6,659,496, 7,182,695 and International Patents Pending. Extreme Engineering, Extreme Engineering's Logo, Speed Harness Fun is our Business, Fly Wire Zipline, High-Action Adventure, Adventure Products, Extreme Air, Rapid Gravity Ride, Cloud Coaster, Flex Pole Technology, Auto-Zip, and Decelerator are U.S. registered trademarks of Extreme Engineering. We take our intellectual property seriously and protect all of our patents, trademarks and copyrights. Our company believes in the protection of ideas so that creative minds can always invent. Help us by honoring originality in this industry. Always buy from this source so that patents can be treated with respect. This material is copyrighted and may not be duplicated without written permission from Extreme Engineering.

Catalog design by: Phil Wilson